

1、 INTRODUCTION	-----	1
2、 ASSEMBLY	-----	1
3、 INSTALLATION	-----	1
4、 PRECAUTION	-----	1
5、 FEATURES	-----	2
6、 AVAILABLE UNITS	-----	2
7、 PANEL AND KEYPAD DEFINITION	-----	2
7、 1 ENTER FUNCTION SETTING	-----	4
7、 2 PARAMETER SETTING	-----	4
BACKLIGHT SETTING	-----	4
FILTER SETTING	-----	4
ZERO BAND SETTING	-----	5
BAND RATE SETTING	-----	5
BUZZER SETTING	-----	5
CHECK-WEIGHING MODE SETTING	-----	5
CHECK-WEIGHING MEMORY SETTING	-----	6
RS232 OUTPUT FORMAT SETTING	-----	6
EXTERNAL DEVICE SETTING	-----	6
AUTO TARE SETTING	-----	6
RS232 OUTPUT CONTENT SETTING (net weight)	-----	7
RS232 OUTPUT CONTENT SETTING (accumulation value)	-----	7
UNITS SETTING	-----	7
INITIAL UNITS SETTING	-----	7
BACK TO NORMAL WEIGHING MODE	-----	8
8、 KEYPAD	-----	8
ZERO	-----	8
TARE	-----	8
PRE-TARE	-----	9
0~9 AND ●	-----	9
INPUT ELIMINATE	-----	9
WEIGHING FUNCTIONS CONVERSION	-----	10
UNITS CONVERSION	-----	10
SAMPLE IN PCS AND % MODE	-----	10
PRINT	-----	10
RETURN	-----	10
NET AND GROSS WEIGHT CONVERSION	-----	10
ACCUMULATION	-----	11
ACCUMULATION DISPLAY	-----	12
ACCUMULATION ELIMINATE	-----	13
CHECK-WEIGHING	-----	14
AUTO TARE	-----	14
9、 MODEL SETTING	-----	15
10、 CALIBRATION	-----	16
SINGLE POINT CALIBRATION	-----	16
11、 RTC	-----	17
RTC TIME DISPLAY	-----	18
RTC TIME SETTING	-----	19
12、 ERROR MESSAGE	-----	20
12.1 ERROR MESSAGE	-----	20
12.2 TROUBLE SHOOTING	-----	20
13、 INTERNAL RESOLUTION	-----	20
14、 RS232 OUTPUT FORMAT	-----	21

1、 INTRODUCTION: ---

Thank you for your purchase of a Hengx high resolution electronic scale. This scale enables you to measure the quality and weight. The scale is easy to operate, precise, stable and with fast display reaction. It is applicable in the electronic, hardware, plastic, medicine, textile and various other industries. It is useful for packaging, inventory and various production and quality control cases.

2、 ASSEMBLY: ---

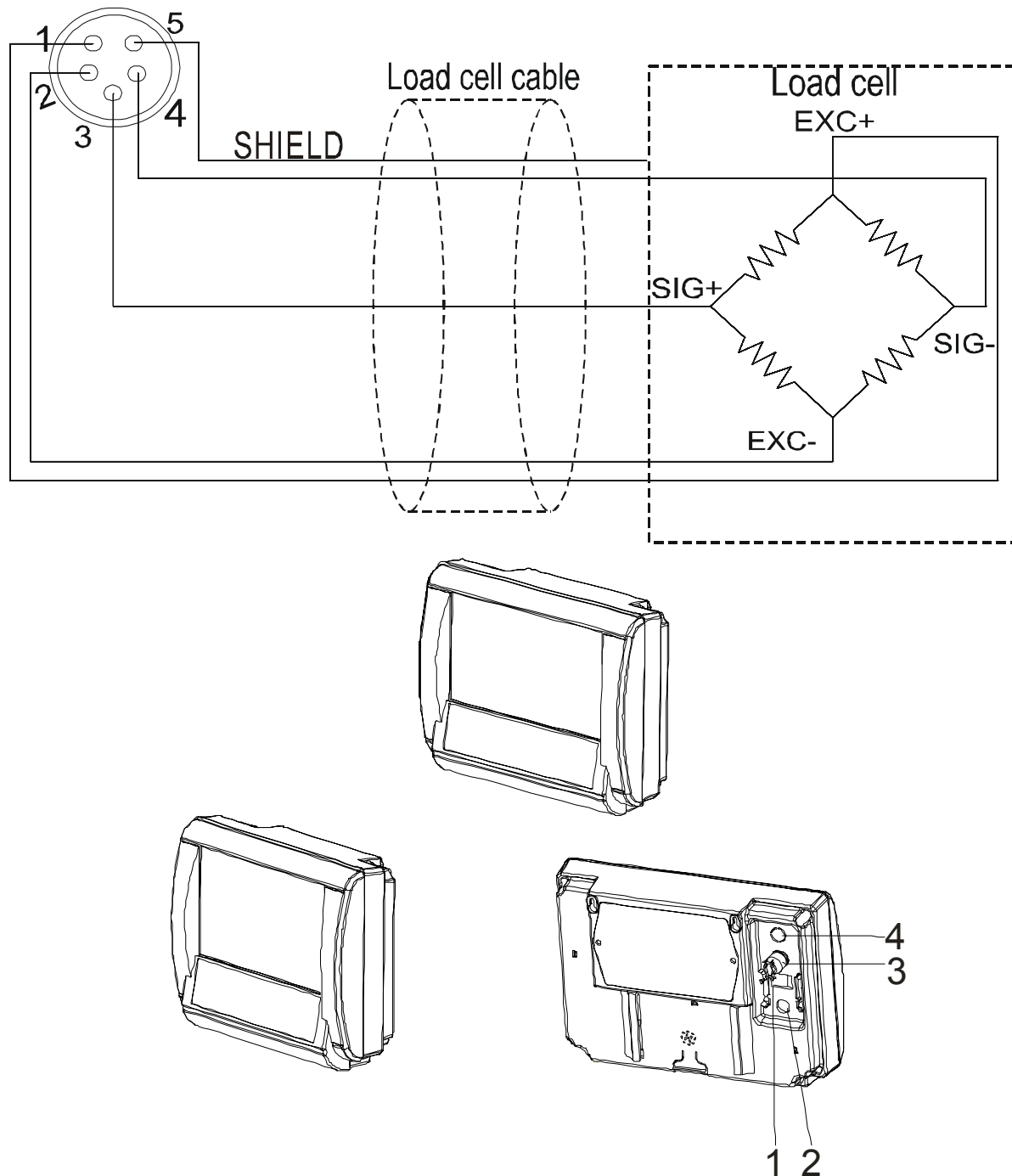

3、 INSTALLATION: ---

- 【1】 Power switch
- 【2】 DC power socket
- 【3】 LOAD CELL interface
- 【4】 RS232 interface

4、 PRECAUTION: ---

- 1) full charge the battery after unpacking the scale.
- 2) recharge the battery: when battery symbol appears on the LCD display, please plug in the power cord to charge the battery. The indicator of charge will light up in red. When it becomes green means charge completed (it takes about 8hours to full recharge the battery)*
- 3) install the equipment on a level and stable surface.
- 4) do not install the equipment near the air condition or a vibrating machine.
- 5) Please in the temperature of 0°C~ 40°C, prevent from rapid temperature changes.
- 6) independent AC outlet for this equipment is recommended, check the voltage before plug in.
- 7) warm up the equipment for 15 minutes before use.

5. FEATURES: ---









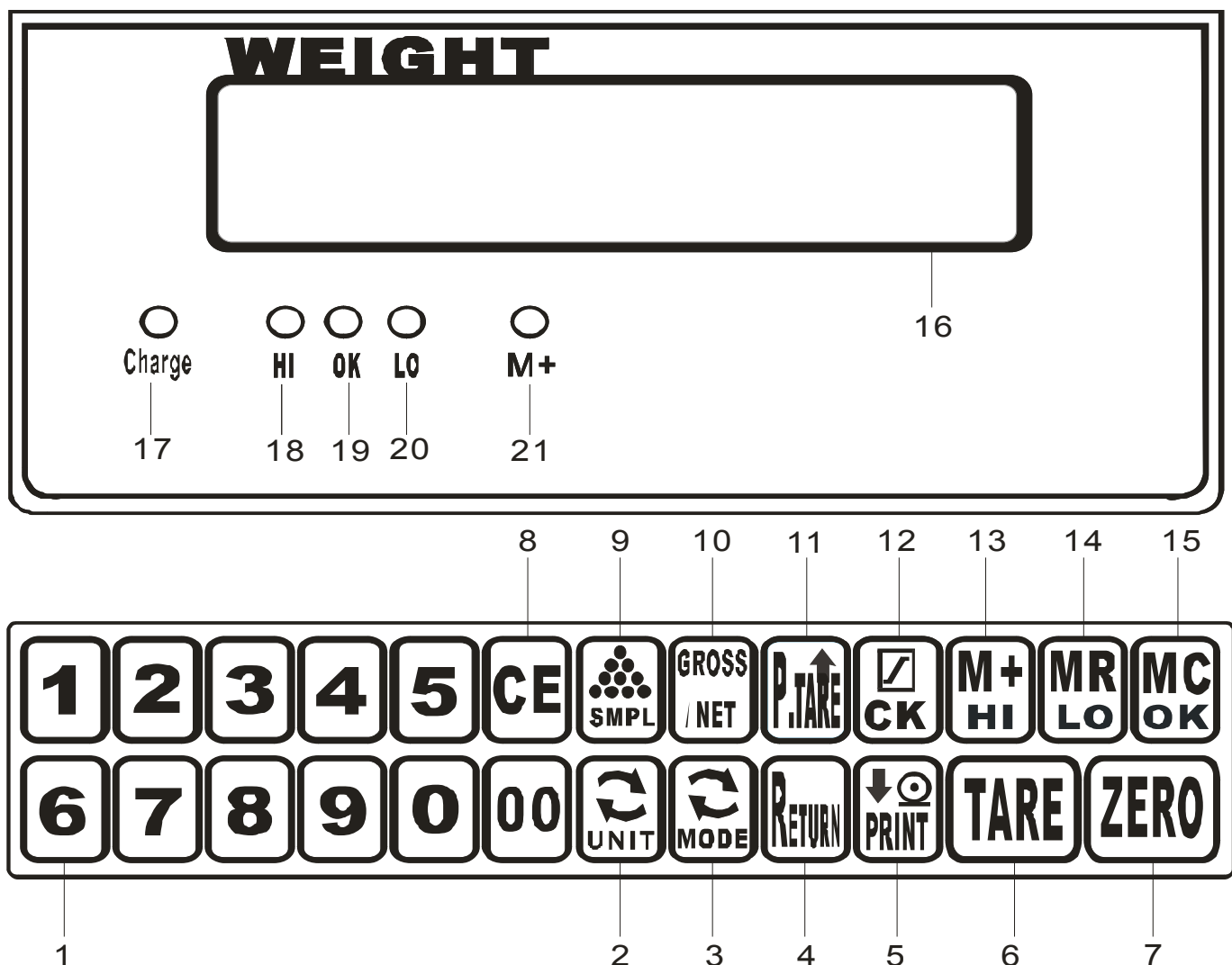





1. the microprocessor in this scale features:
 - A. automatic zero point tracking function
 - B. tare, pre-tare and auto tare function
 - C. weight HI/LOW setting
 - D. MAX accumulation (10sets)
 - E. Each accumulation value print
 - F. Total accumulation value print
 - G. BACKLIGHT AUTO ON
 - H. 2 sets of RS-232 Uni-direction or Bi-direction (option)
 - I. Relay output (option)
 - J. Mini printer (option)
 - K. with RTC (option)
2. clear LCD display, with 22mm digits
3. backlight function
4. over load and transportation protection
5. membrane keypad, easy operation and nice water-resistant function







6. AVAILABLE UNITS: ---

1. 1 kg = 1000g
2. 1 t = 1000kg
3. 1 lb = 453.59237g
4. 1 tlt = 0.5999992kg
5. 1 tlh = 0.60479kg
6. PCS
7. %

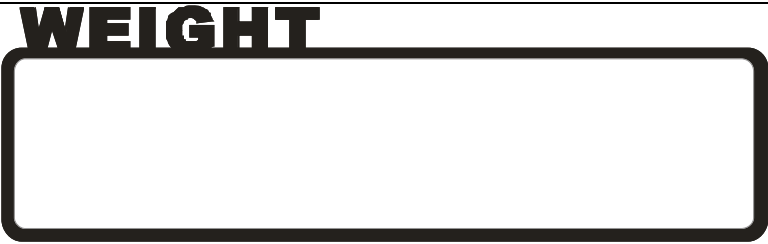









7. PANEL AND KEYPAD DEFINITION: ---



keypad					
1		Used for inputting number data			
2		Units conversion	9		Put samples onto the pan, and input the number, then press "sample"
3		Weighing mode conversion	10		Net weight/ total weight conversion
4		Return	11		For pre-tare ↑ (used to check in accumulation display and eliminate)
5		For print ↓ (used to check in unit weight warning and accumulation memory function)	12		Press to enter weight, quantity and HI/LO/OK check-weighing setting
6		When some weight on the pan, Press "tare" to tare	13		Press "accumulation" to accumulate (totally 10 times) (HI used for check-weighing)
7		To come into zero	14		Press this key to enter accumulation display function, (LO used for check-weighing)
8		To clear the input data	15		Press this key to clear accumulation value (OK used for check-weighing)

Panel illuminate					
1 6			Display weight		
1 7		Recharge instruction	1 8		Check-weighing bigger than instruction
1 9		Check-weighing equals with instruction	2 0		Check-weighing smaller than instruction
2 1		Enter accumulation			



7、 1 ENTER FUNCTION SETTING:

KEYPAD	FUNCTION
	Parameter setting
ON/OFF +  +  + 	OFFSET value display
ON/OFF +  +  +  + 	weighing mode
ON/OFF + 	Input 11 to enter into single point calibration mode RTC on/off, display and setting
ON/OFF +  + 	Enter initial setting

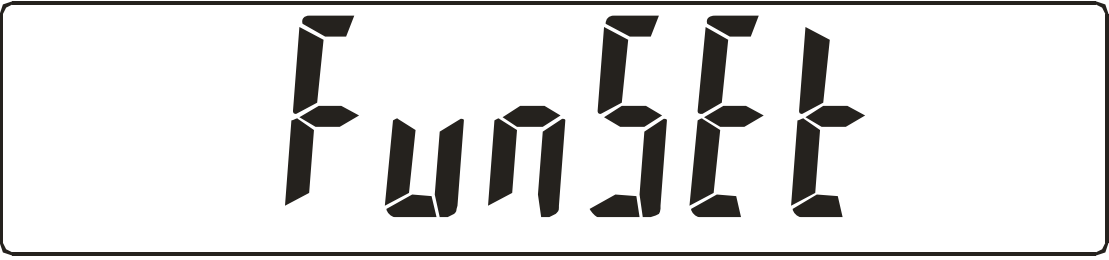

7、 2 PARAMETER SETTING: (lineation words are the initiatory value)

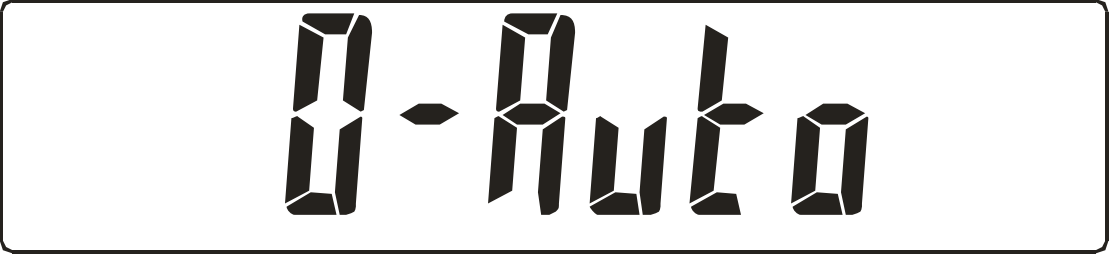
OPERATION	LCD display
press  to switch on:	

Backlight setting:

press  : ● on / off / <u>auto</u> (“on” means the backlight is always be light; “off” means the backlight is turn down; “auto” means the backlight will on when there is weight on it.)	
press  to select in turn	

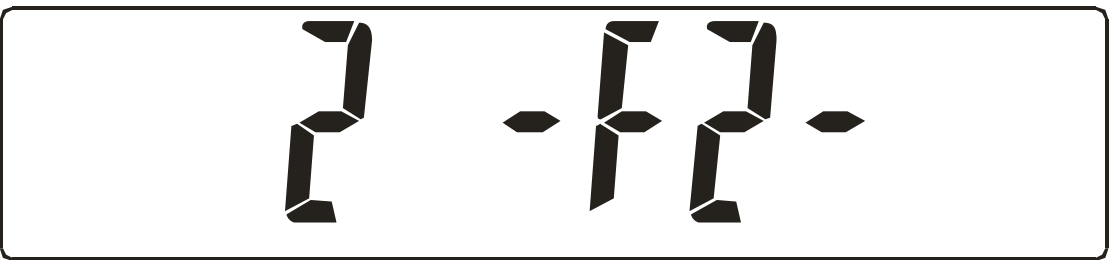
Filter setting:

press  : ● F1 / <u>F2</u> / F4 / F8 (higher value, higher filter grade)	
press  to select in turn	

Zero band setting:

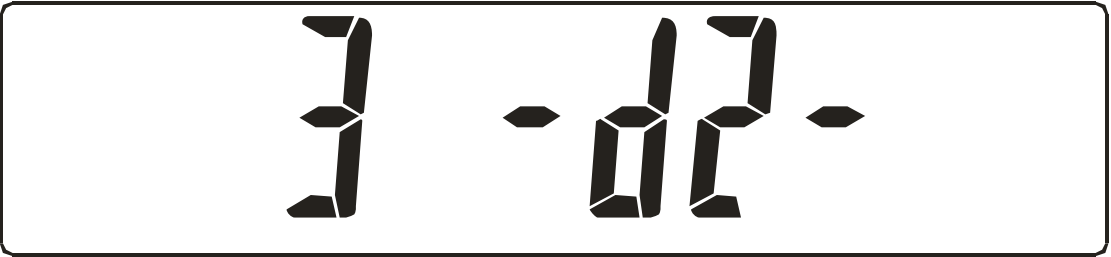
<p>press 3 :</p> <ul style="list-style-type: none">• d0 / d1 / <u>d2</u> / d3 / d4 / d5 (more bigger means auto zero tracking more bigger) <p>press 3 to select in turn</p>	
--	--

Band rate setting:

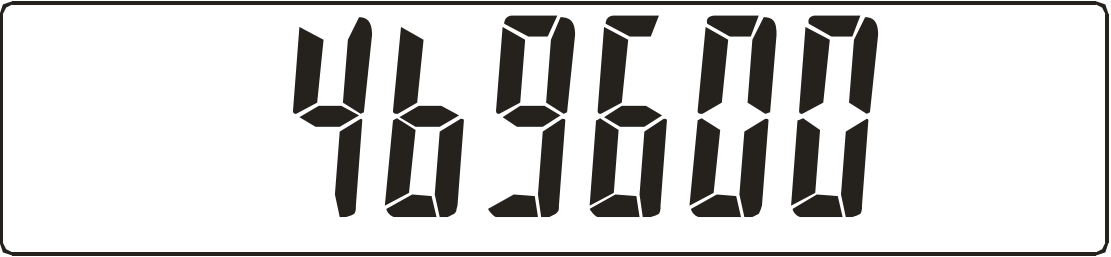
<p>press 4 :</p> <ul style="list-style-type: none">• band rate setting: 9600	
--	--

Buzzer setting:

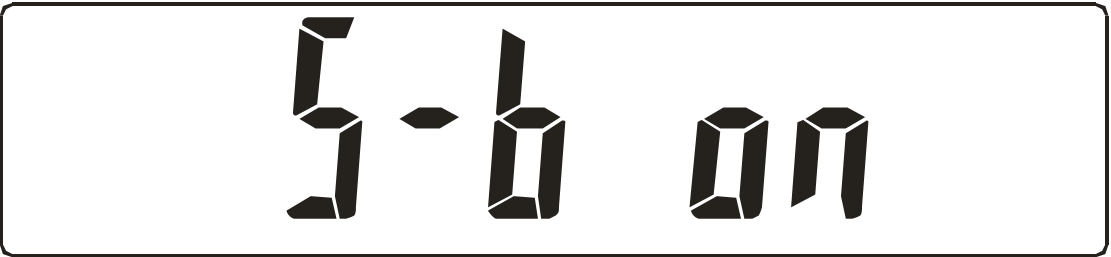
<p>press 5 :</p> <ul style="list-style-type: none">• on(buzzer on) / oFF(buzzer off) <p>press 5 to select in turn</p>	
---	--

Check-weighing mode setting:

<p>press 6 :</p> <ul style="list-style-type: none">• HI(upper)/ Lo(lower)/ In(during upper value to lower value) / un (outside the value)/ 3b(3 point)/ oK(1 point) / oFF(close)• (totally we have 3 value to set. For example, if you set 3kg for HI, and 1kg for LO, and 2kg for OK, then if you want it warning when upper than 3kg, then you choose HI, if you want it warning when lower than 1kg, then you choose LO, if you want it warning when during 1kg-3kg, then you choose IN, if you want it warning when upper than 3kg and lower than 1kg, then you choose Un, if you want it warning just in 3kg, 2kg, and 1kg, then you choose 3b, if you want it warning in 2kg, then you choose OK, if you do want any warning, then you choose OFF.) <p>press 6 to select in turn</p>	
--	--

Check-weighing memory setting:

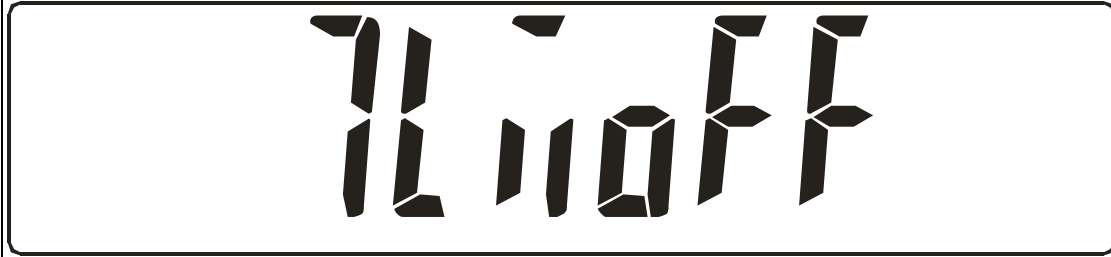
<p>press 7 :</p> <ul style="list-style-type: none">● M.On / M.oFF <p>("M.On" means check-weighing memory is open; "M.oFF" means check-weighing memory is closed)</p> <p>press 7 to select in turn</p>	
--	--

RS232 output format setting:

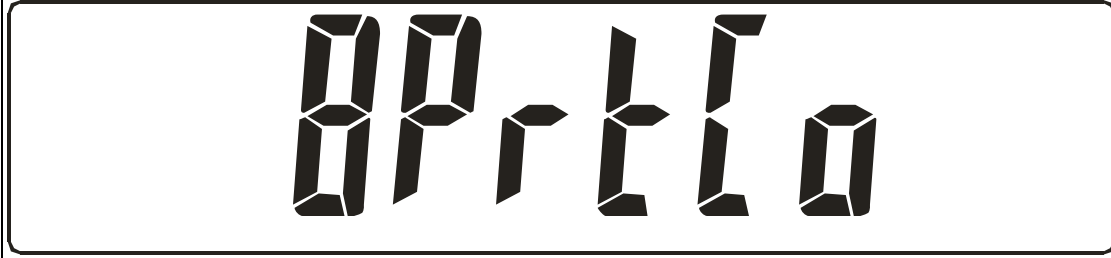
<p>press 8 :</p> <ul style="list-style-type: none">● Prt.Pr -data sent when key pressed (can do data sending in dual direction, see page 21)● Prt.Co- data sent continuously● Prt.St-data sent auto matically when stable symbol show <p>press 8 to select in turn</p>	
---	---

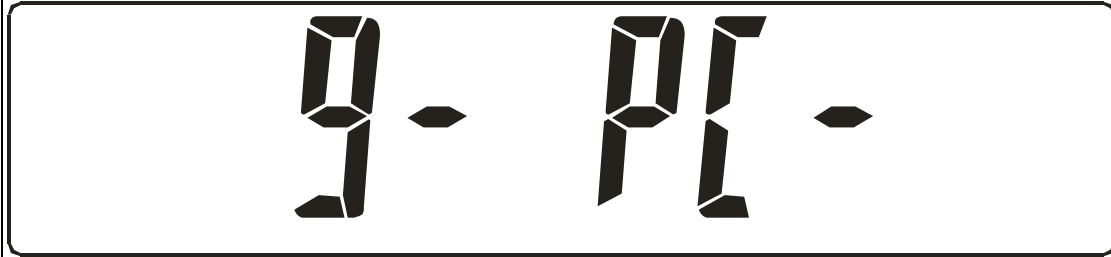

External device setting:

<p>press 9 :</p> <ul style="list-style-type: none">● PC / SH / TDP / SCR("PC" means connect to computer; "SH" means connect to matrix printer; "TDP" means connect to thermal printer; "SCR" means connect to large screen.) <p>press 9 to select in turn</p>	
--	--

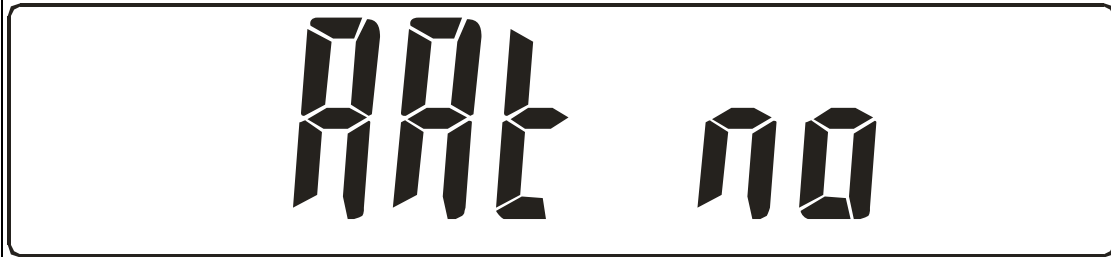

Auto-tare setting:

<p>press 00 :</p> <ul style="list-style-type: none">● YES / NO <p>press 00 to select in turn</p>	
---	--

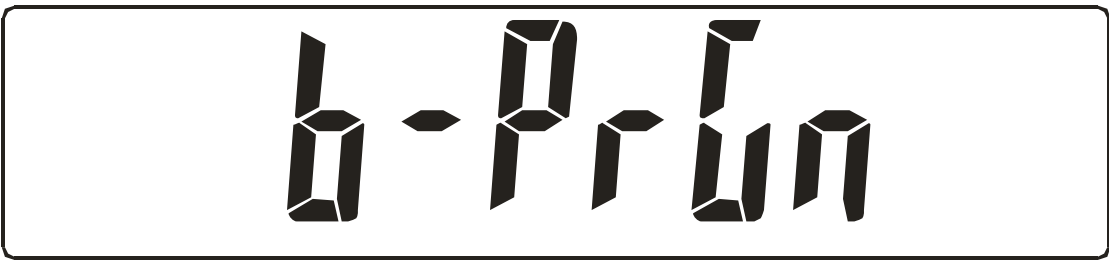

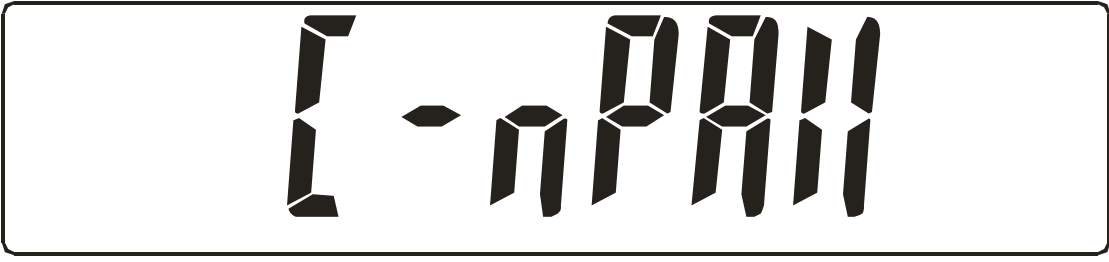

RS232 output content setting(net weight):

<p>press  :</p> <ul style="list-style-type: none"> ● Pr/ nP ("Pr" means print; "nP" means not print) <p>press  to select in turn</p>	
--	--

RS232 output content setting(accumulation value):

<p>press  :</p> <ul style="list-style-type: none"> ● Pr/ nP ("Pr" means print; "nP" means not print) <p>press  to select in turn</p>	
---	--

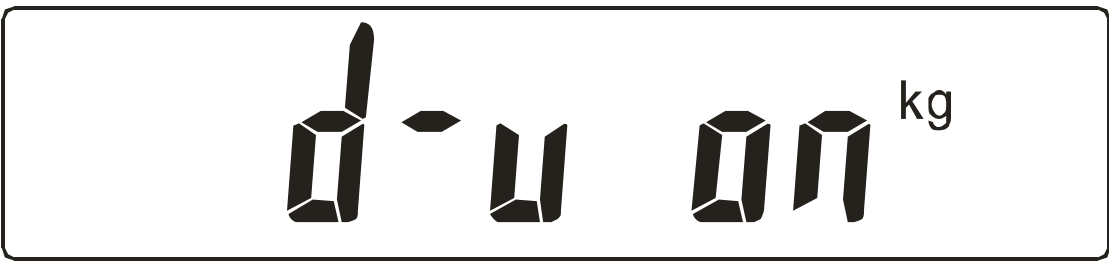
Units setting:

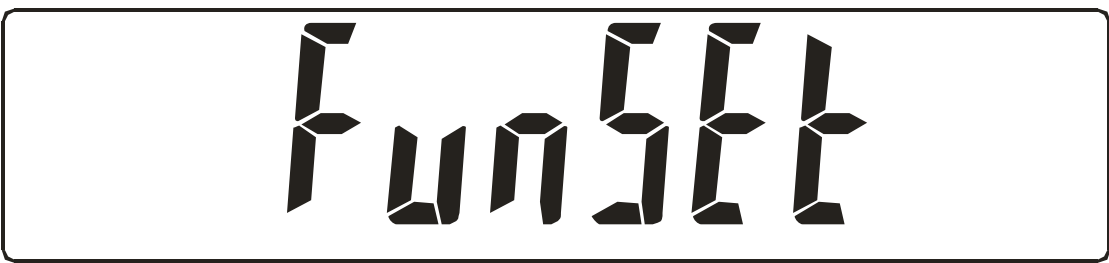
<p>press  :</p> <p>press  :</p> <ul style="list-style-type: none"> ● oN / oFF("on" means you choose this unit on ;"off" means that you close this unit. <p>press  : to select in turn</p>	
<p>press  : enter parameter setting</p>	

Initial units setting:

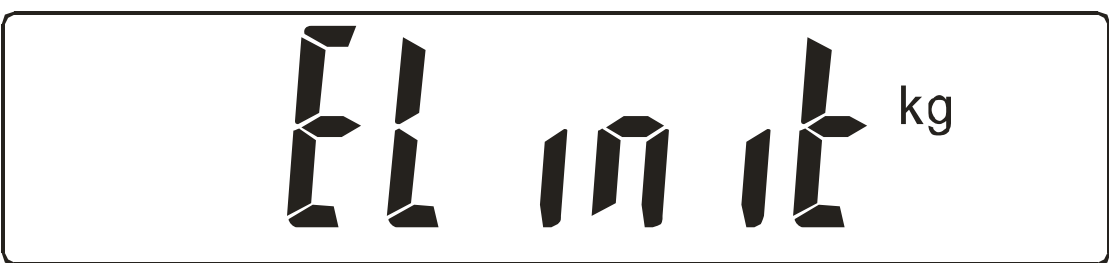
<p>press  :</p> <p>press  again to select in turn</p>	
---	--

Back to normal weighing mode :

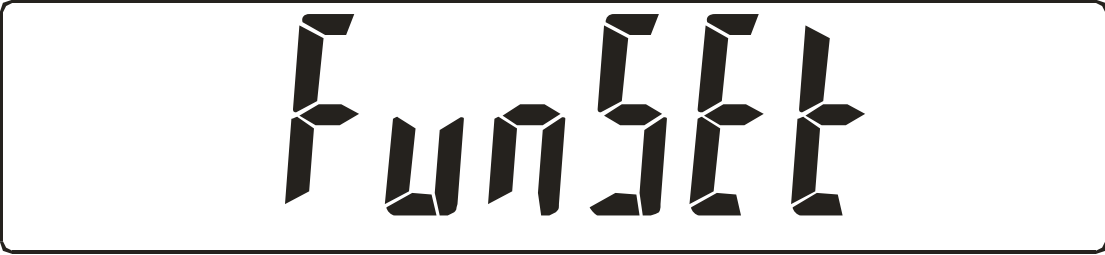
<p>ZERO</p> <p>press : after countdown back to normal weighing mode</p>	
--	--

8. KEYPAD: ---



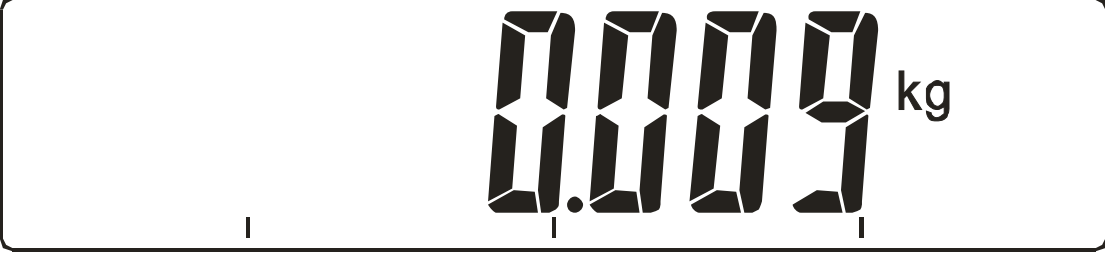
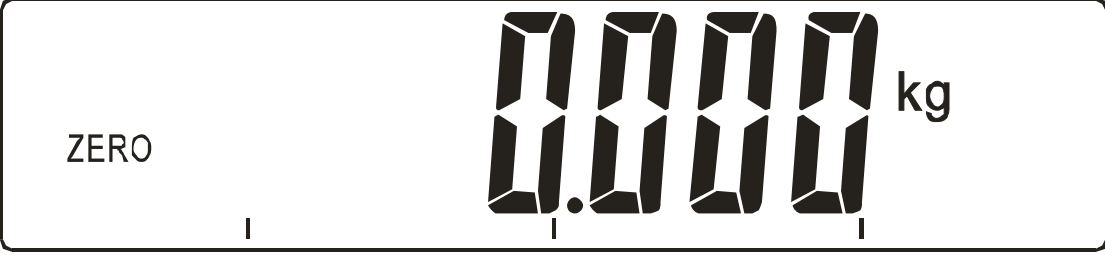



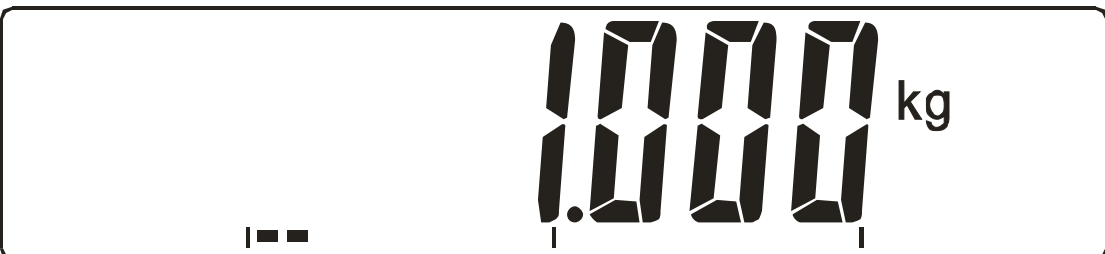
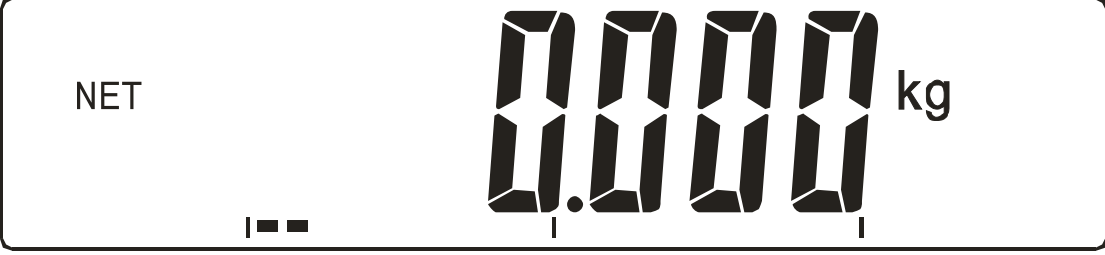

Zero:

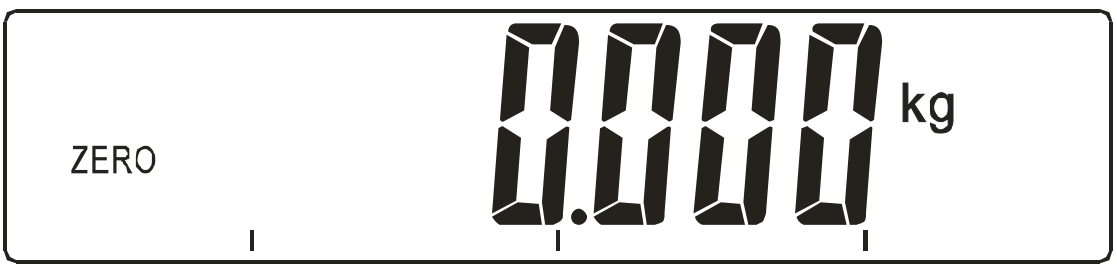
OPERATION	LCD display
	
<p>● press ZERO :</p>	<p>ZERO</p> 

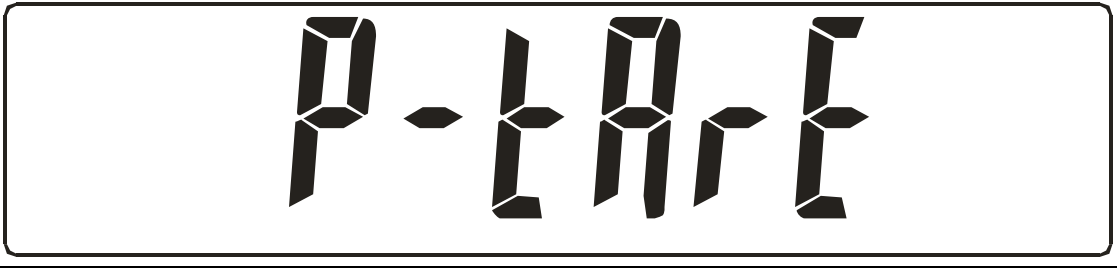
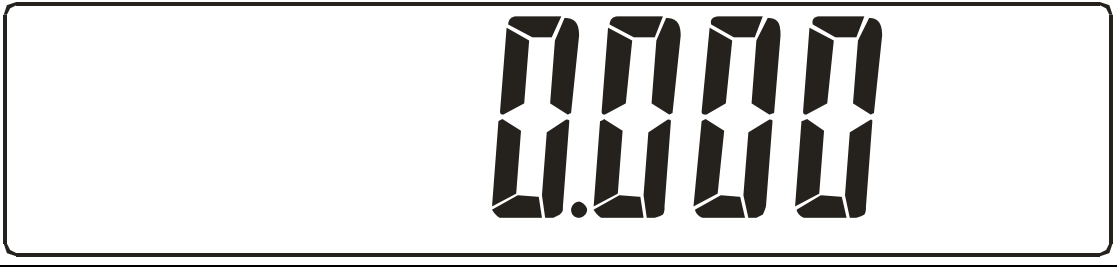

Tare:

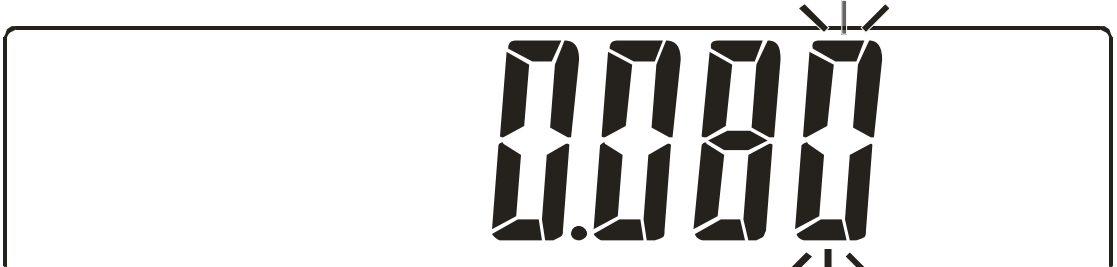
	
<p>● press TARE :</p> <p>● condition : can't work below zero(minus value) nor above max capacity</p>	<p>NET</p> 

Pre-tare:

	
<p>press </p>	
	
<ul style="list-style-type: none"> • pre  ~  and  to input pre-tare value. 	
<ul style="list-style-type: none"> • press  : • condition : zero symbol should display on 	

0~9 and ●:

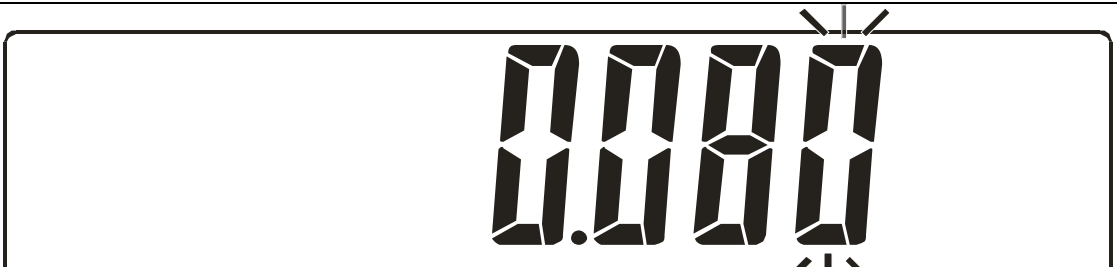
<ul style="list-style-type: none"> •  ~  and  • to load the pre-tare value and check-weighing 	
--	--

Input eliminate:

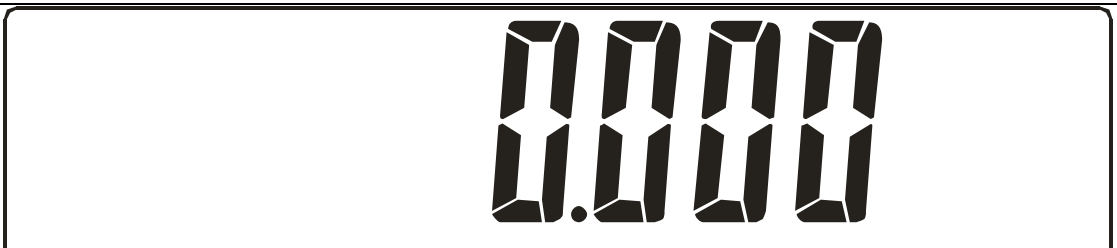
<ul style="list-style-type: none"> • press  • in the pre-tare, check-weighing mode 	
---	--



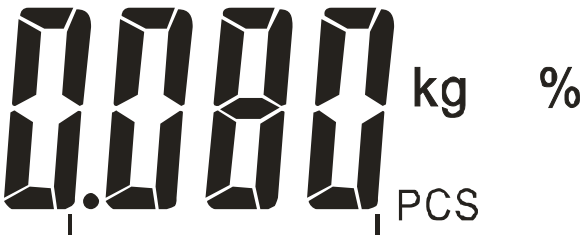

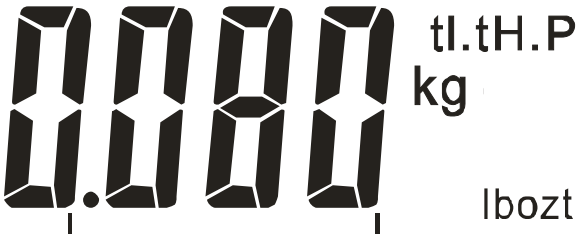

Weighing function conversion:

<ul style="list-style-type: none"> ● press  ● used for weighing, pcs and % mode 	
--	---

Units conversion:

<ul style="list-style-type: none"> ● press  ● for weighing units conversion 	
--	---

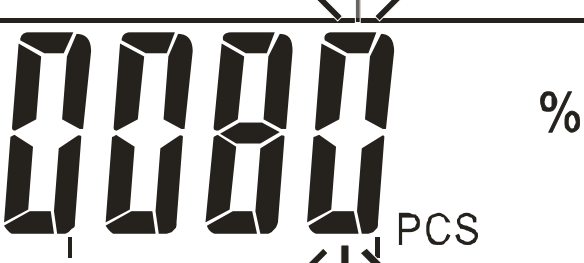
Sample in PCS and % mode :

<ul style="list-style-type: none"> ● in PCS and % mode 	
<ul style="list-style-type: none"> ● press  ~  and  to load quantity. 	
<ul style="list-style-type: none"> ● put on object press  to sample 	

Print :

<p>condition: in the stable mode, press  : print LCD display value</p>





Return :

<p>press  : return to weighing mode</p>
--



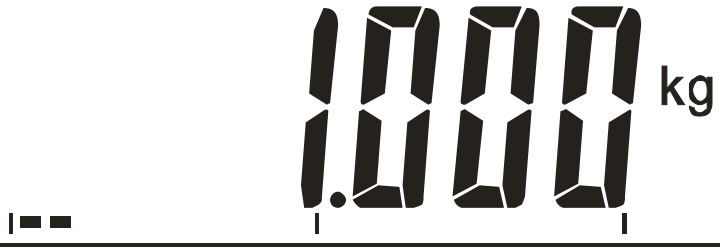

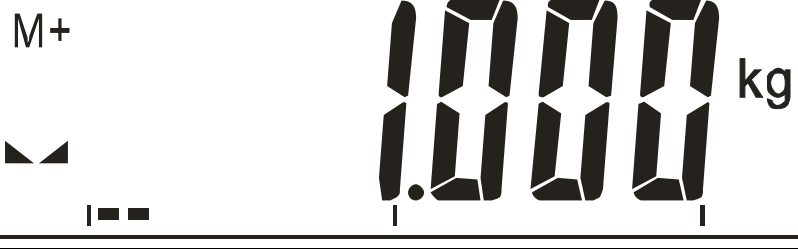





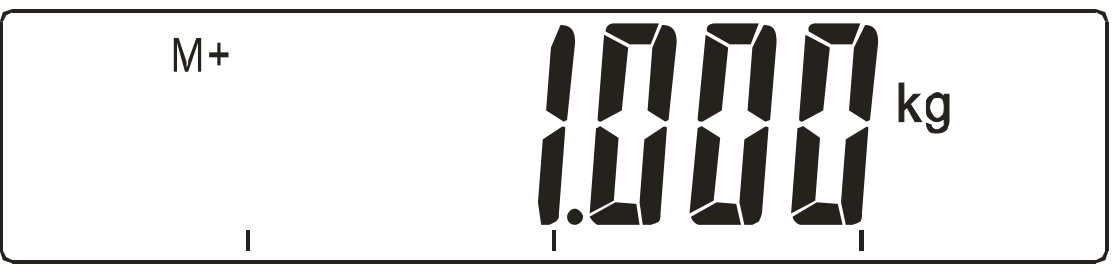

Net and gross weight conversion :

<p>press  : net and gross weight conversion</p>
--











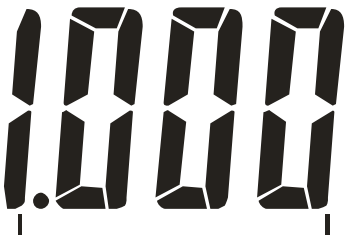

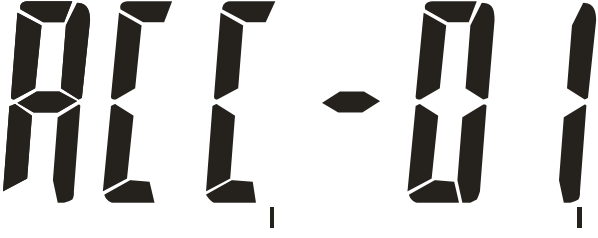

Accumulation :

	
<ul style="list-style-type: none"> ● press  perform accumulation ● condition: in the stable condition, only can accumulate once, remove objects on the pan and could accumulate once more. Totally can accumulate for 10 times ● 1 sec later back to normal weighing mode 	
	
<ul style="list-style-type: none"> ● when accumulation more than 10 times ● means : accumulate times over range. 1 sec. Later back to normal weighing mode 	

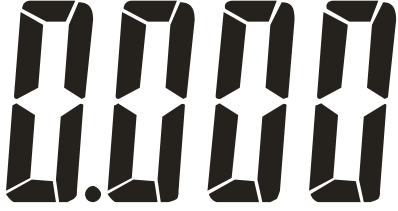

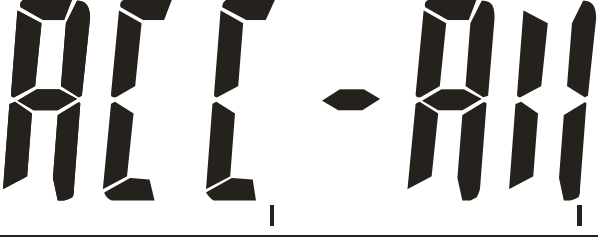



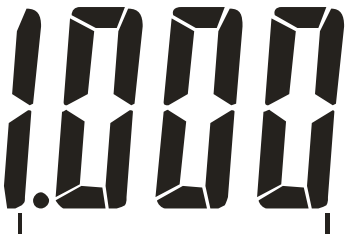



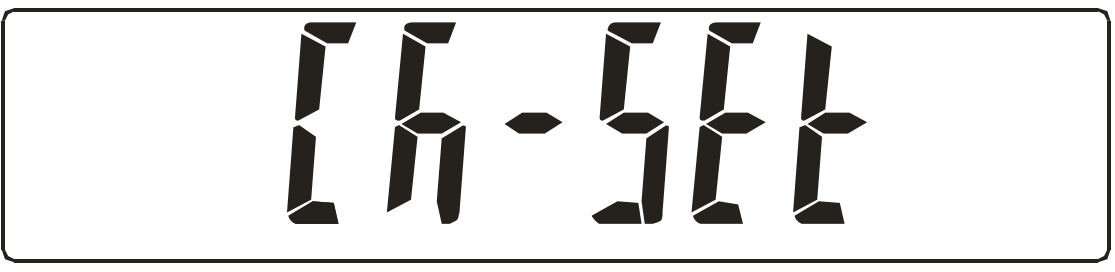

Accumulation display :

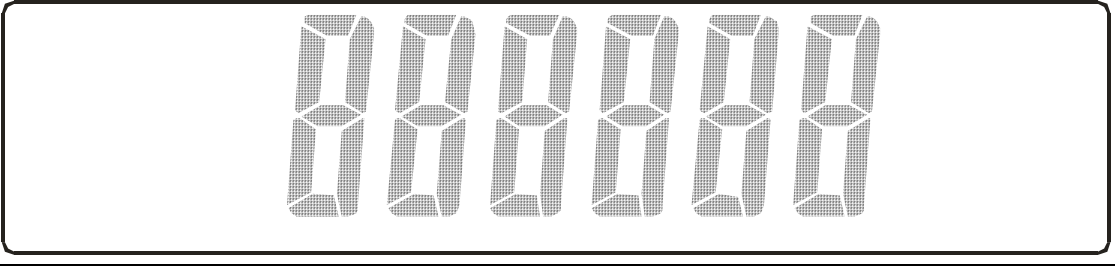
<ul style="list-style-type: none"> press  , perform accumulation display accumulation indicator lights 	
<ul style="list-style-type: none"> press  ~  or  or  to select accumulation time. 	
<ul style="list-style-type: none"> press  means: accumulate the first time, accumulate quantity of individual accumulation 	
<ul style="list-style-type: none"> press  means: accumulate total weight, total times and total quantities. 	
<ul style="list-style-type: none"> press  back to normal weighing mode when total value of accumulation over display range, it shows  press  to get the current accumulation value 	

Accumulation eliminate :

<ul style="list-style-type: none"> press  to perform accumulation display accumulation indicator lights 	<p>M+  kg</p>
<p>press   or  or  to select accumulation value and eliminate</p>	
<ul style="list-style-type: none"> press  means: accumulate the first accumulation and accumulate individual quantities 	<p></p>
<ul style="list-style-type: none"> press  to cancel accumulation value 	<p></p>
<ul style="list-style-type: none"> press  means: total accumulation weight, total accumulation times and total accumulation quantities 	<p></p>
<ul style="list-style-type: none"> press  to cancel accumulation value 	<p></p>
<ul style="list-style-type: none"> press  back to normal weighing mode press  to get the current accumulation value 	<p>M+  kg</p>

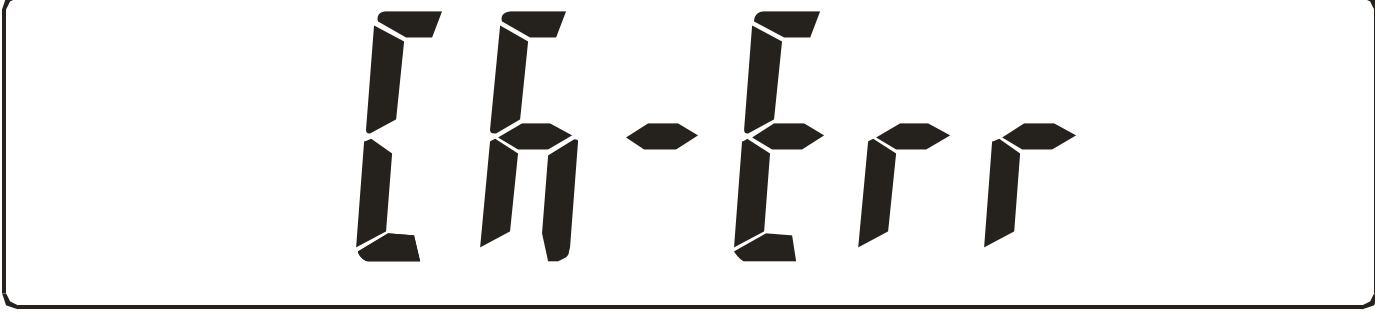













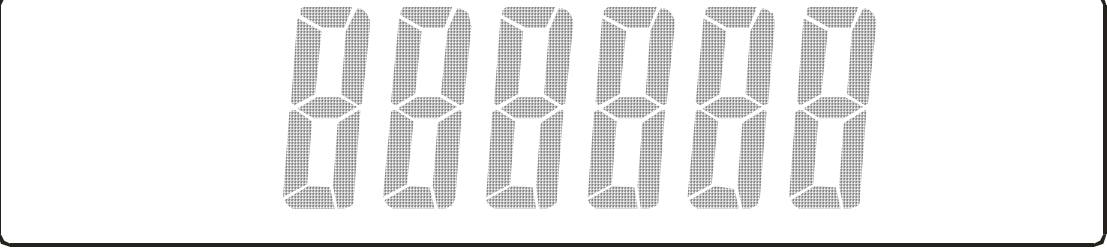

Check-weighing :



<ul style="list-style-type: none"> press  	
<ul style="list-style-type: none"> press  ,  ,  to select the check-weighing value 	
<ul style="list-style-type: none"> select check-weighing condition and press  ~  and  to load check-weighing range press  to confirm the loading of check-weighing range press  back to normal weighing mode. When check-weighing setting wrong, it shows 	
	
<ul style="list-style-type: none"> press  and  to cancel check-weighing and back to normal weighing mode 	

Auto-tare :

- auto-tare condition: can't work below zero or above max capacity. In the stable condition, max≥2%
- Can not tare constantly (after auto tare, press "tare" to cancel pre-tare and get new tare value)
- if need another auto tare, clear the pan, press "zero" or "tare" to re-tare. ,

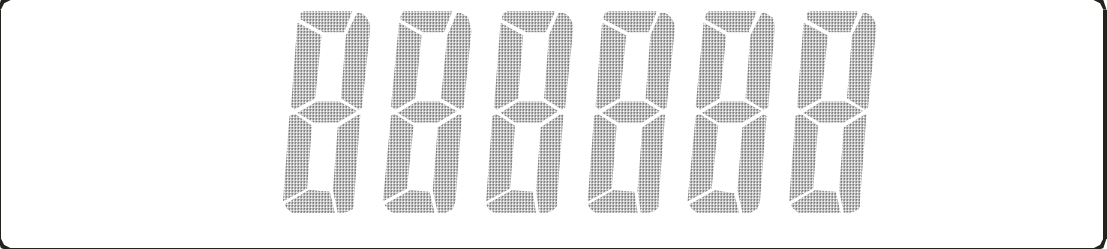

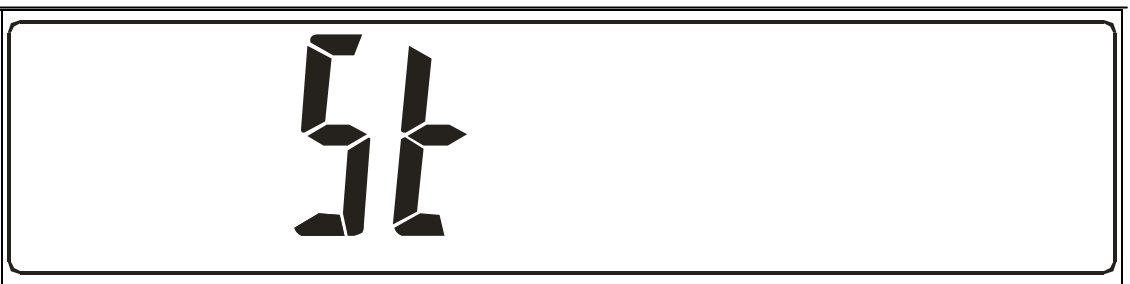





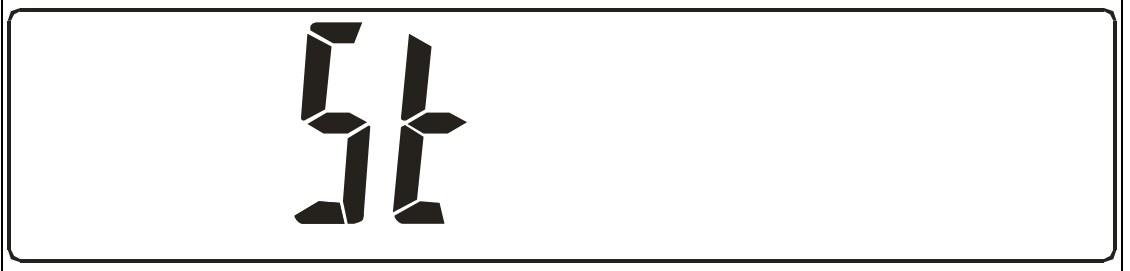

9. CAPACITY AND RESOLUTION SETTING: ---

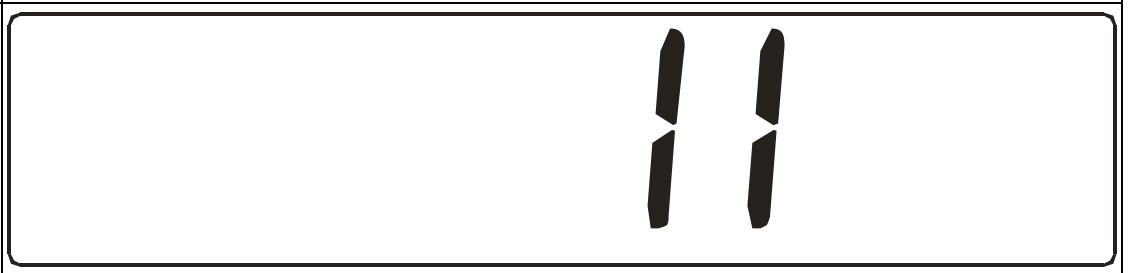

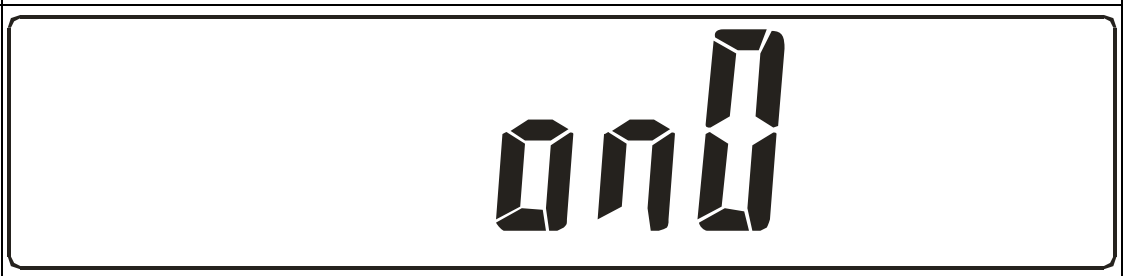
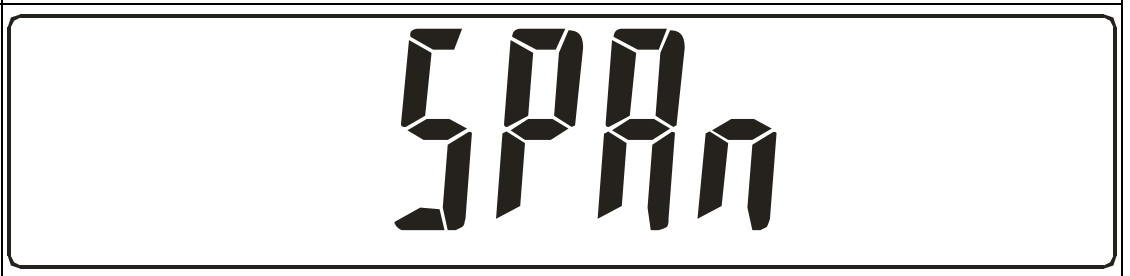
OPERATION	LCD display
<ul style="list-style-type: none"> press  to switch on the scale 	
<ul style="list-style-type: none"> press     	
<ul style="list-style-type: none"> press  	
<ul style="list-style-type: none"> press  to enter resolution setting press  and  to select min. division in turn press  to enter decimal point setting press  and  to select position of decimal point in turn press  enter max capacity selecting mode press  and  to select max capacity 	

<ul style="list-style-type: none"> press  : 	
<ul style="list-style-type: none"> press  back to normal weighing mode 	

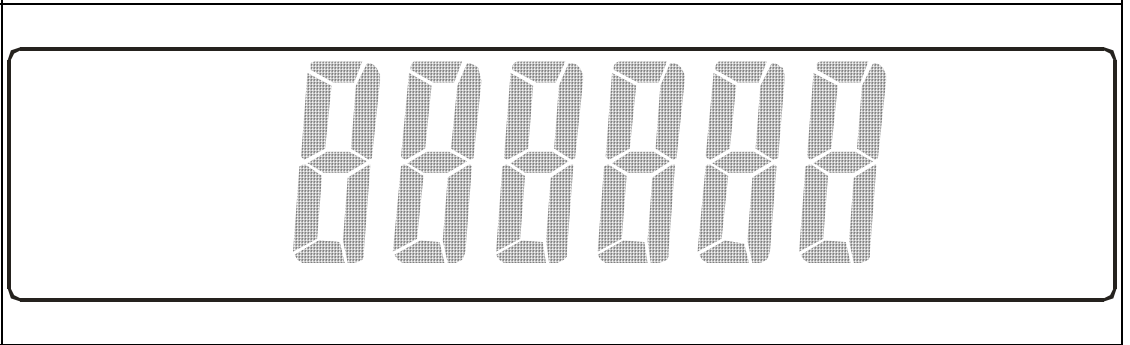



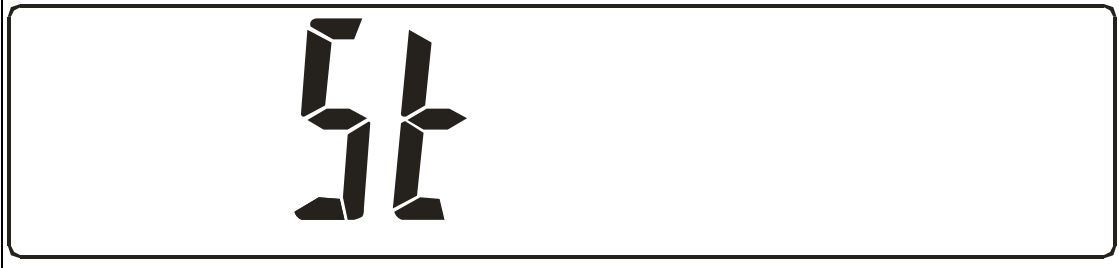



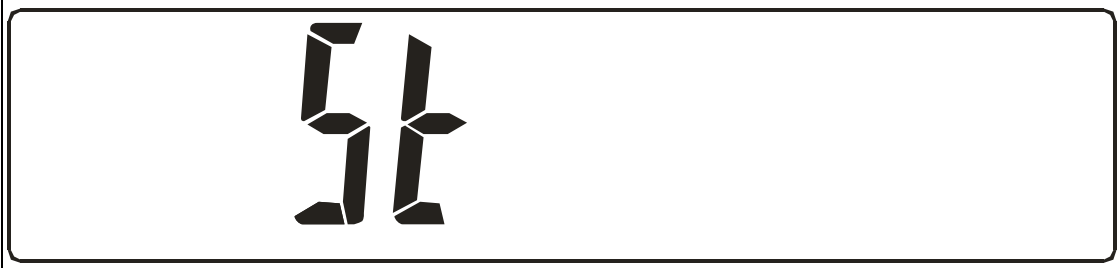

10. CALIBRATION: ---

Single point calibration :

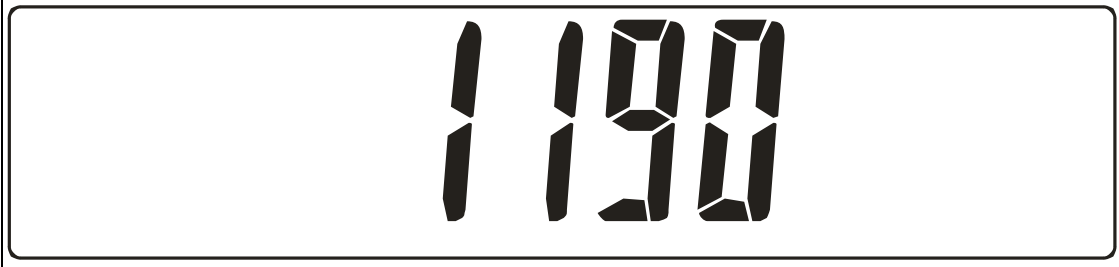







OPERATION	LCD display
<ul style="list-style-type: none"> press  to switch on the scale 	
<ul style="list-style-type: none"> press   	
<ul style="list-style-type: none"> press  	
<ul style="list-style-type: none"> place weights of equivalent weight 	
<ul style="list-style-type: none"> press  ~  to load weight (kg) press  	
<ul style="list-style-type: none"> wait 	

<ul style="list-style-type: none"> press  	
<ul style="list-style-type: none"> press  back to normal weighing mode 	

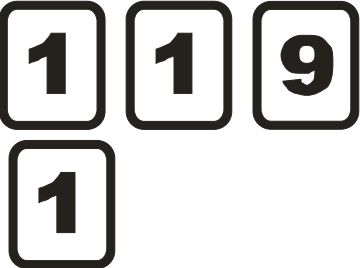
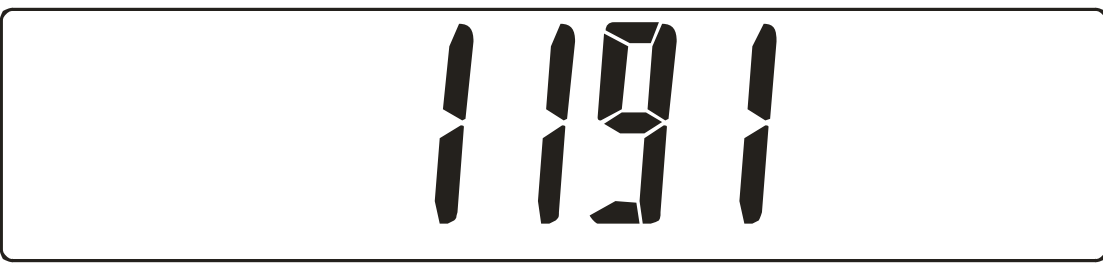

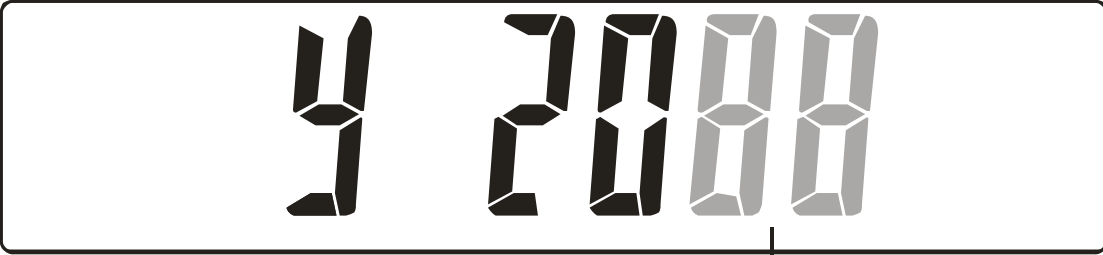
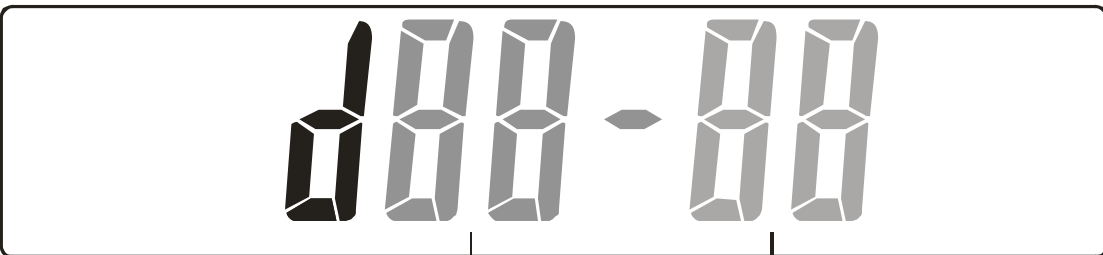
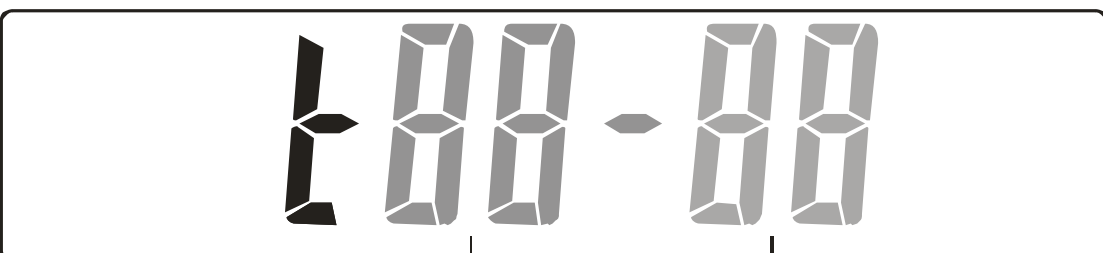











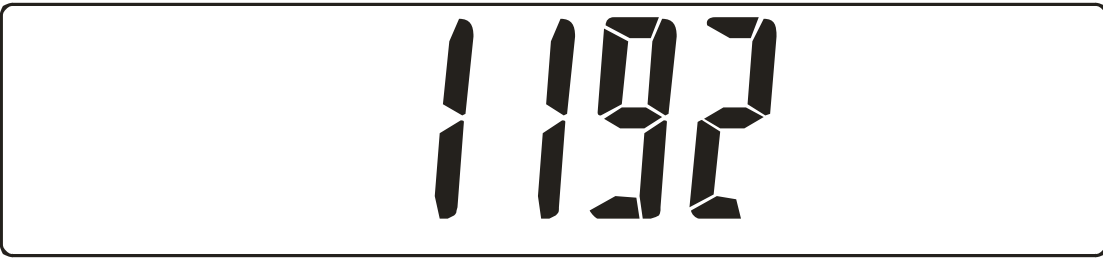

11、RTC: ---

<ul style="list-style-type: none"> press  to switch on the machine 	
<ul style="list-style-type: none"> press     	
<ul style="list-style-type: none"> press  	
<ul style="list-style-type: none"> press  to choose: on(with RTC)/oFF(without RTC) 	
<ul style="list-style-type: none"> press  	
<ul style="list-style-type: none"> press  back to normal weighing mode. 	

RTC time display :

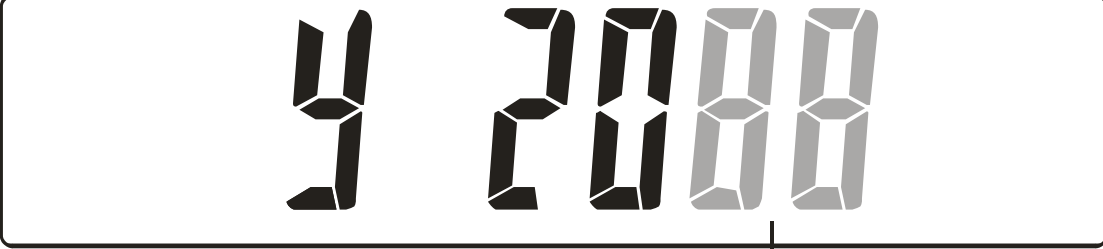
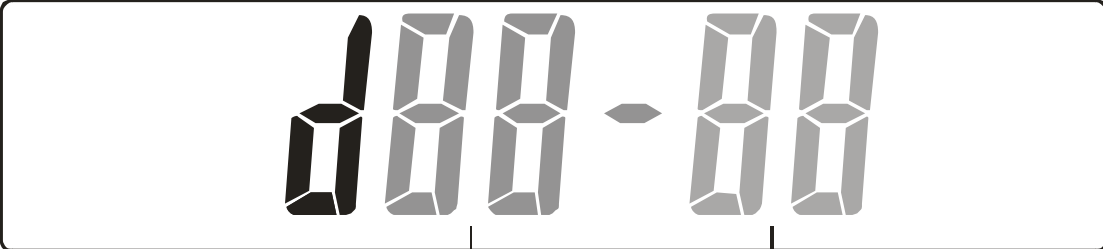
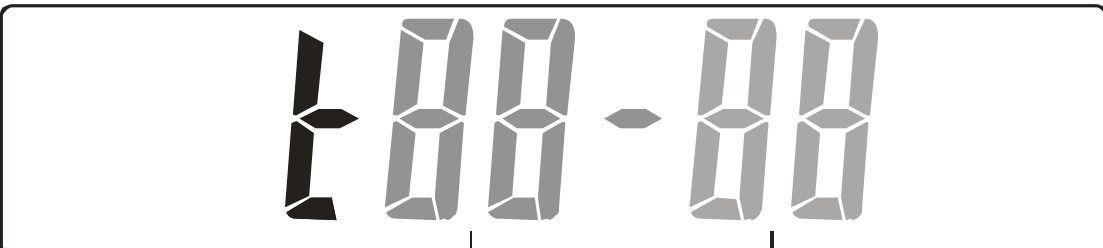
operation	LCD display
<ul style="list-style-type: none"> press  to switch on the machine 	
<ul style="list-style-type: none"> press  	
<ul style="list-style-type: none"> press  press  to choose in turn 	 <p style="text-align: center;">YEAR</p>  <p style="text-align: center;">MONTH DATE</p>  <p style="text-align: center;">HOUR MINUTE</p>
<ul style="list-style-type: none"> press  	
<ul style="list-style-type: none"> press  back to normal weighing mode 	

RTC time setting :

operation	LCD display
<ul style="list-style-type: none"> press  to switch on the machine 	
<ul style="list-style-type: none"> press     	
<ul style="list-style-type: none"> press  press  to choose in turn press  ~  from left to right, to load year, month, date and time, then press  	 <p style="text-align: center;">YEAR</p>  <p style="text-align: center;">MONTH DATE</p>  <p style="text-align: center;">HOUR MINUTE</p>
<ul style="list-style-type: none"> press  	
<ul style="list-style-type: none"> press  back to normal weighing mode 	

12. ERROR MESSAGE: ---

12.1 Error message: -

Error message	problem	
Err2	Initial zero over +/-20%	
Err5	Over load (max capacity+9e)	
ACC.ov	Accumulate over 10 times	
over	Display value over range	
Err7	Min.division, decimal point position or max capacity setting wrong	
Battery symbol	Low battery	
LOBAT	Low voltage	

12.2 Trouble shooting:

when	Error message	Trouble shooting
Switch on	Err2,	Check if there is object on the pan or load cell trouble
Switch on	Battery symbol	recharge
Normal weighing operation	Err5	Check if over max capacity+9e,Err
Model setting	Err7	Setting again
Normal weighing operation	LOBAT	Plug in alternating current to switch again

13. Internal resolution: ---

Max capacity	Internal resolution					
	1d	2d	5d	10d	20d	50d
300	1/300					
400	1/400					
500	1/500					
600	1/600	1/300				
800	1/800	1/400				
1,000	1/1000	1/500				
1,200	1/1200	1/600				
1,500	1/1500	1/750	1/300			
2,000	1/2000	1/1000	1/400			
2,500	1/2500	1/1250	1/500			
3,000	1/3000	1/1500	1/600	1/300		
4,000	1/4000	1/2000	1/800	1/400		
5,000	1/5000	1/2500	1/1000	1/500		
6,000	1/6000	1/3000	1/1200	1/600	1/300	
8,000	1/8000	1/4000	1/1600	1/800	1/400	
10,000	1/10000	1/5000	1/2000	1/1000	1/500	
12,000	1/12000	1/6000	1/2400	1/1200	1/600	
15,000	1/15000	1/7500	1/3000	1/1500	1/750	1/300
20,000	1/20000	1/10000	1/4000	1/2000	1/1000	1/400
25,000	1/25000	1/12000	1/5000	1/2500	1/1250	1/500
30,000	1/30000	1/15000	1/6000	1/3000	1/1500	1/600
40,000		1/20000	1/8000	1/4000	1/2000	1/800
50,000		1/25000	1/10000	1/5000	1/2500	1/1000
60,000		1/30000	1/12000	1/6000	1/3000	1/1200
80,000			1/16000	1/8000	1/4000	1/1600
100,000			1/20000	1/10000	1/5000	1/2000
120,000			1/24000	1/12000	1/6000	1/2400
150,000			1/30000	1/15000	1/7500	1/3000
200,000				1/20000	1/10000	1/4000

250,000				1/25000	1/12000	1/5000
300,000				1/30000	1/15000	1/6000
400,000					1/20000	1/8000
500,000					1/25000	1/10000
600,000					1/30000	1/12000
700,000						1/14000
750,000						1/15000

14. RS232 output format: ---

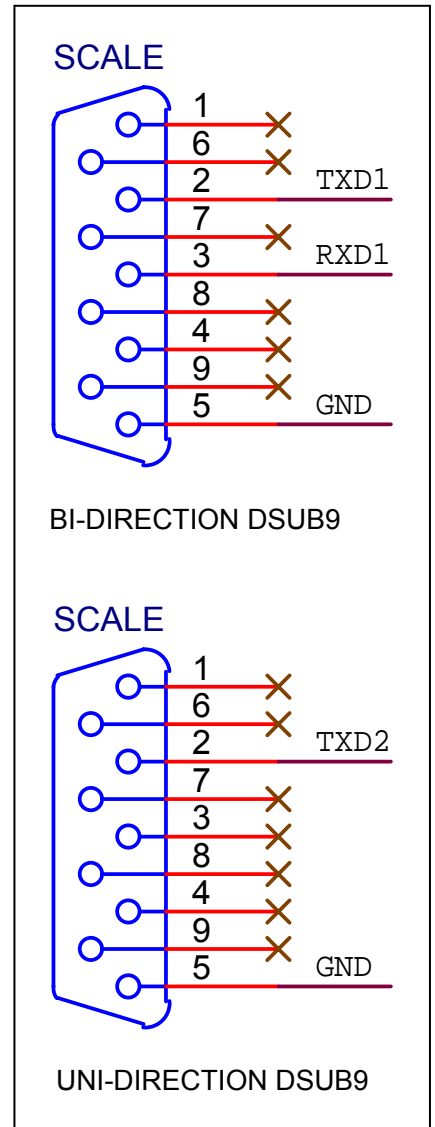
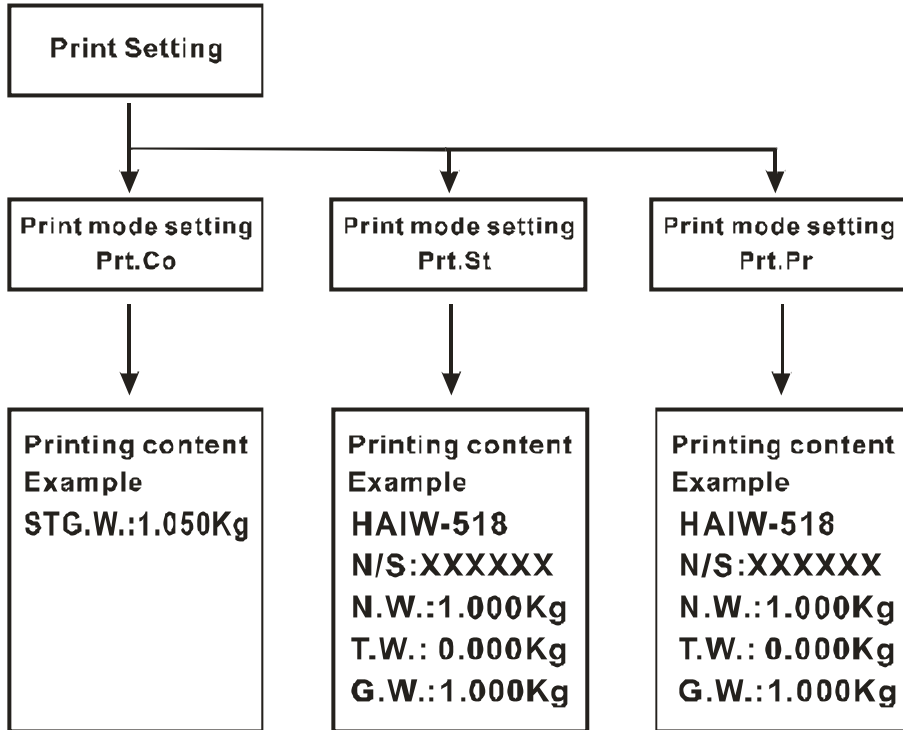

Remarks for Dual output: 1. data can be sent in dual direction when you choose Prt.Pr;

2. it equals with pressing **ZERO** when computer send "Z" to scale;

it equals with pressing **TARE** when computer send "T" to scale;

it equals with pressing **PRINT** when computer send "R" to scale;

RS-232 serial interface

The 9PIN interface in the right back is the standard interface of RS-232, 3rd PIN is output, 5th PIN is grounded, the rest is useless.

BAUD RATE: **9600 bps** DATA BIT: **8** PARITY BIT: **N(ONE)** STOP BIT: **1** CODE: **ASCII**

BIT FORMAT:

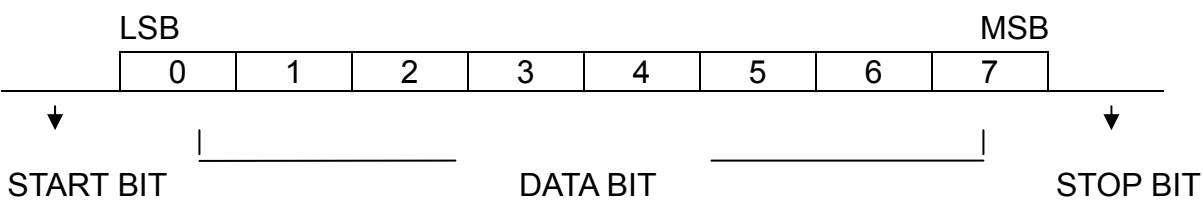

DATA FORMAT: (Prt.Co)

S/U	T	G/N	.	W	.	:	+/-										K	g					LF	CR
																	l	b					LF	CR
																	t						LF	CR
																	T	-	j	i	n	g	LF	CR
																	H	-	j	i	n	g	LF	CR
																	P	C	S				LF	CR
																	%						LF	CR
UNIT																								

e.g.

ST G.W.: 1.050 kg

DATA FORMAT: (Prt.St Prt.Pr)

H	A	I	W	-	5	1	8	LF	CR																
N	/	S	:	NS1	NS2	NS3	NS4	NS5	NS6	LF	CR														
N	.	W	.	:	+/-												k	g					LF	CR	
																	l	b					LF	CR	
																	t						LF	CR	
																	T	-	j	i	n	g	LF	CR	
																	H	-	j	i	n	g	LF	CR	
																	P	C	S				LF	CR	
																	%						LF	CR	
T	.	W	.	:													k	g					LF	CR	
																	l	b					LF	CR	
																	t						LF	CR	
																	T	-	j	i	n	g	LF	CR	
																	H	-	j	i	n	g	LF	CR	
																	P	C	S				LF	CR	
																	%						LF	CR	
G	.	W	.	:													k	g					LF	CR	
																	l	b					LF	CR	
																	t						LF	CR	
																	T	-	j	i	n	g	LF	CR	
																	H	-	j	i	n	g	LF	CR	
																	P	C	S				LF	CR	
																	%						LF	CR	
UNIT																									

e.g.

HAIW-518

N/S:XXXXXX

N.W.: 1.000 XX

T.W.: 0.000 XX

G.W.: 1.000 XX
